



PRODUCT DESCRIPTION

RoDrink water tanks are used for collecting and storage of drinking water. Tanks are made of one piece of polyethylene [PE Dowlex 2432] which is certified and suitable for drinking water.

A various inlet and outlet pipe diameters can be arranged on the tank.

The design and dimensions of the RoDrink tank make it easy to manipulate and install on the construction site. For easy adjustment to the terrain, an extension ϕ 600 x 300 mm which can be cut off, is installed on the tank.







The tank enables the installation of various additional equipment such as: pumps, valve technology, filter systems and level meters.

The tank has been tested in accordance with the relevant standards and normatives for collecting and storing drinking water.

TECHNICAL DATA RoDrink 8000 L

Technical data	Values
Volume	8000 L
Dimensions L x D x H [mm]	2680 x 2300 x 2450 - 2700
Installation	Underground installation
Diameter of revision openings	Φ 600 mm
Material	Polyethylene [PE Dowlex 2432]
UV resistant material	Yes
Drinking water reservoir	Yes
Diameter of inflow pipe	DN 110, DN 125, DN 160
Diameter of outflow pipe	DN 110, DN 125, DN 160
Standard	SIST EN 12566 - 3
Cover	PE walk-on cover

RODRINK WATER TANK ADVANTAGES

-  **Easy and fast installation**
-  **Suitable for drinking water**
-  **Long life service**
-  **Easy manipulation on the construction site**
-  **Possibility of installation of various inlet and outlet pipes**
-  **Slovenian product**

MECHANICAL RESISTANCE AND STABILITY

Mechanical resistance and stability checked (Report no.: P 0865 / 12 – 680 - 2) by the institute:
Slovenian national building and civil engineering institute, Dimičeva ulica 12, 1000 Ljubljana



WATERTIGHTNESS

Watertightness checked (Report no.: P 0865 / 12 – 680 – 1) by the institute:
Slovenian national building and civil engineering institute, Dimičeva ulica 12, 1000 Ljubljana



MATERIALS INTENDED FOR TANKS WITH DRINKING WATER

Checked (2131b – 19 / 62083 – 19 / 47434) by the institute:
National laboratory of health, environment and food, Prvomajska 1, 2000 Maribor



SUITABILITY FOR DRINKING WATER

Checked (REG2 - 0004 - 04 - ZGpro1 - 2731) by the institute:
Slovenian national building and civil engineering institute, Dimičeva ulica 12, 1000 Ljubljana

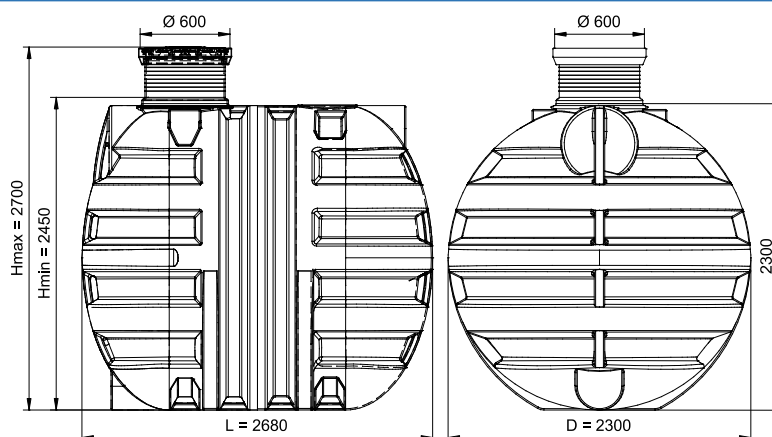

ADDITIONAL INFORMATIONS

WATER TANK INSTALLATION

Water tank installation is fast and easy and can be made in a few hours. Excavate the pit, install the tank and fill it with the water at the same time. Connect it to the inflow and the outflow pipes (various standard pipes possibility). Reservoir can be installed by Roto experts. Installation must be made according general instructions accessed on the QR code.



Instructions for installation



Roto Eco d.o.o.

Puconci 12, 9201 Puconci,

SLOVENIA

Customer support: (+386) 2 5252 152

Technical support: (+386) 2 5252 196

Web page: www.rotoECO.eu

All rights are reserved, including the rights of photomechanical reproductions and storage on electronic media. The manufacturer reserves the rights to change the product. Any commercial use of the processes and working procedures assumed in this document is prohibited. Although information, texts and photos were carefully collected. The mistakes can not be completely excluded. The publisher and editors can not assume legal responsibility or guarantee any incorrect information. The publisher and editors are grateful for any possible suggestions for improvements and warnings of possible mistakes in the text.